



STAINLESS STEEL

marine accessories · industrial equipment · architecture · fasteners



News 2017



Unser neues Firmengebäude
Our new building



Die Marinetechnik Edelstahlhandel GmbH & Co. KG ist mit seinen zur Zeit 70 Mitarbeiter/-innen einer der größten europäischen Anbieter für rostfreies Boots- und Yachtzubehör sowie Edelstahlverbindungselemente.

Zu unseren Kunden zählen alle namhaften europäischen Werften, Yachtbauer, der maritime Großhandel und weitere maritime Industriebereiche.

An unserem neuen Firmensitz, direkt an der Weser im Bremer Norden, haben wir jetzt eine Lagerfläche von mehr als 6.000 qm, ein vollautomatisches Kleinteilelager mit mehr als 36.000 Stellplätzen und 3.000 Palettenplätze.

Wir prüfen und erweitern ständig unser Sortiment und möchten Ihnen hiermit unsere Neuprodukte für die Saison 2017 vorstellen.

With its 70 employees, Marinetechnik Edelstahlhandel GmbH Co. KG is one of the largest European suppliers of rust-free boat and yacht equipment and stainless steel fastening elements.

Our clients include all the biggest names in shipyards and yacht builders in the European maritime wholesale trade and industry.

At our new office directly on the Weser in the north of Bremen, we now have storage facilities of over 6000 m², a fully automated small parts warehouse with more than 36,000 units as well as 3000 pallet bays.

We are constantly monitoring and extending our range and would now like to present you with the latest additions for 2017.



Rundschäkel mit Innensechskant und Sicherungsmutter / A4-AISI 316
D-Shackle with hexagon socket and safety nut

814839

Bestell-Nr. Order no.	Ø	A	B	L	BL/Kg	Box	*€/Stück *€/piece
814839406	6	12	24	21	1500	10	2,10
814839408	8	16	32	28	2200	10	3,20

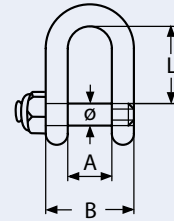

Wirbelschäkel, Gabel-Gabel mit Innensechskant und Sicherungsmutter / A4-AISI 316
Jaw and Jaw swivel shackle with hexagon socket and safety nut

814840

Bestell-Nr. Order no.	Ø	L	B	A	BL/Kg	Box	*€/Stück *€/piece
814840406	6	66	12	11	1350	10	4,50
814840408	8	88	16	16	2500	10	8,60

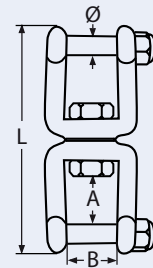

Karabinerhaken, asymmetrisch / A4-AISI 316
Asymmetric spring hook

814841

Bestell-Nr. Order no.	Ø	L	C	D	B	BL/Kg	Box	*€/Stück *€/piece
814841406 60	6	60	10	9	35	700	10	2,70
814841408 80	8	80	13	12	46,5	870	10	4,80
814841410 100	10	100	17	15	60	1350	5	7,50
814841411 120	11	120	22	18	70	1500	5	10,00

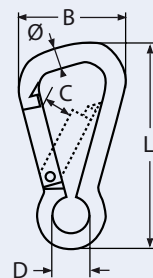

Doppelkarabinerhaken / A4-AISI 316
Double spring hook

814844

Bestell-Nr. Order no.	L	B	C	D	Box	*€/Stück *€/piece
8148444080	80	24	10	10,5	5	1,50
8148444110	110	31	12	13	5	2,90
8148444150	150	46	22	21	2	7,30



814842

Sportflasche mit Karabiner / Edelstahl

Sport flask with spring hook stainless steel



Bestell-Nr. Order no.	Liter	Box	*€/Stück *€/piece
8148422075	0,75	1	10,00

Karabinerhaken aus Aluminium.
Spring hook made of aluminium.

814843

Pilzanker / Stahl PVC-beschichtet

Mushroom anchor steel pvc coated

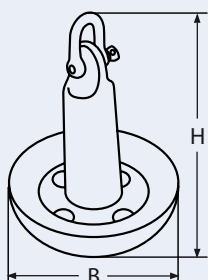

Bestell-Nr. Order no.	KG	H	B	Box	*€/Stück *€/piece
8148431036	3,6	200	180	1	42,00
8148431045	4,5	210	200	1	53,00
8148431012	12	290	280	1	135,00

814845

Fenderkorb, dreifach, gerade / A4-AISI 316

Tripple fender holder, straight

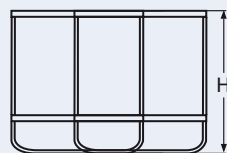
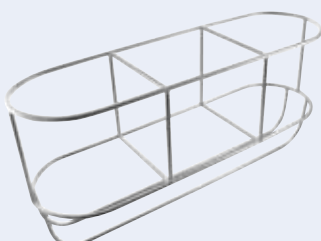

Bestell-Nr. Order no.	Fender-Ø max.	L	B	H	Box	*€/Stück *€/piece
8148454180	180	632	190	285	1	196,00
8148454220	220	814	240	330	1	220,00
8148454300	300	998	330	580	1	290,00

Fenderkorb Drahtstärke 8mm mit Befestigung für 22 - 25mm Reling.
Fender holder wire diameter 8mm with fixing for 22 - 25mm rail.

Fenderkorb ist durch frei montierbare Halterung (3 Stck.) sowohl rechts als auch links montierbar.
Due to variably fender holder suitable for use on both sides left and right.



814846

Fenderkorb, dreifach, schräg / A4-AISI 316

Tripple fender holder, tilt

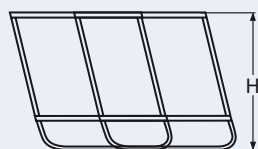
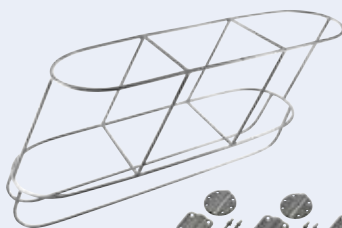

Bestell-Nr. Order no.	Fender-Ø max.	L	B	H	Box	*€/Stück *€/piece
8148464180	180	760	190	285	1	200,00
8148464220	220	950	240	330	1	230,00
8148464300	300	1290	330	580	1	310,00

Fenderkorb Drahtstärke 8mm mit Befestigung für 22 - 25mm Reling.
Fender holder wire diameter 8mm with fixing for 22 - 25mm rail.

Fenderkorb ist durch frei montierbare Halterung (3 Stck.) sowohl rechts als auch links montierbar.
Due to variably fender holder suitable for use on both sides left and right.



USB Anschluss mit Abdeckung
USB charger with cap

814847

Bestell-Nr. Order no.	L	B	Ausgangsleistung Output	Volt	Box	*€/Stück *€/piece
814847350	50	25	2x5Vx3,1A	12-24	1	18,20

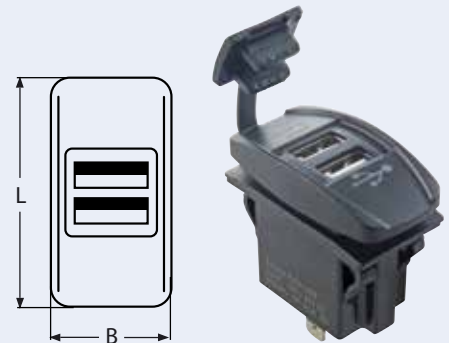

USB Anschluss mit Abdeckung, rund
USB charger with cap, round

814848

Bestell-Nr. Order no.	Ø	Abdeckplatte Covering plate	Ausgangsleistung Output	Volt	Box	*€/Stück *€/piece
8148483365	36,5	60,3 x 42,5	1x5Vx1,0A 1x5Vx2,1A	12	1	15,90

Artikel lässt sich mit und ohne Abdeckplatte montieren.
Item is mountable with and without covering plate.

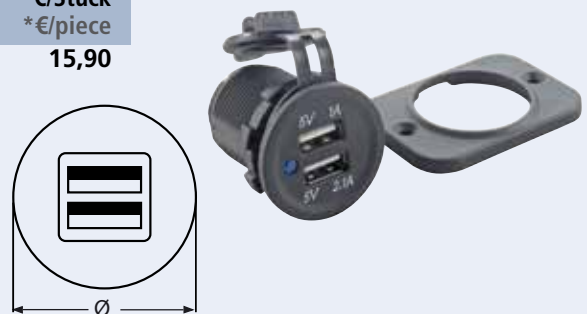

Digitaler Batterie-Tester
Digital battery test switch

814877

Bestell-Nr. Order no.	L	B	Volt	Box	*€/Stück *€/piece
814877082	82	63	12	1	39,90

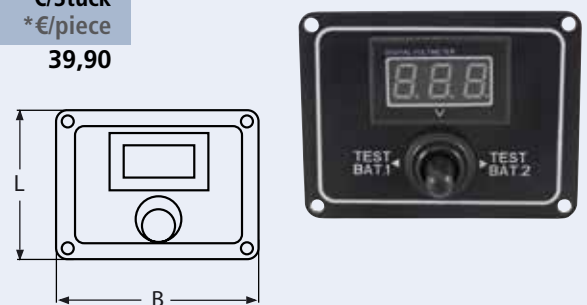

High Power Cree T6 Akku-Stirnleuchte
High power Cree T6 rechargeable head lamp

814849

Bestell-Nr. Order no.	Box	*€/Stück *€/piece
8148490	1	25,00



Inkl. Akkus und Ladegerät.
Incl. batteries and charger.



8628

Edelstahl-Pflegespray
Stainless steel care spray



Bestell-Nr. Order no.	ml	Box	*€/Stück *€/piece
862850	50	1	8,00
8628400	400	1	20,00

814850

Universal Hochglanz-Metallpolitur Unipol blau
Universal metal polish Unipol blue



Bestell-Nr. Order no.	Gramm	Box	*€/Stück *€/piece
814850110	110	1	4,90
814850700	700	1	13,90

Geeignet für Poliermaschinen ab 4000 U/min.
Usable for polishing machines from 4000 rpm.

814851

Universal Hochglanz-Metallpolierpaste Unipol blau
Universal metal polish paste Unipol blue



Bestell-Nr. Order no.	ml	Box	*€/Stück *€/piece
814851	50	1	8,50

814852

Universal Hochglanz-Metallpolierpaste Unipol blau - Set
Universal metal polish paste Unipol blue - Set



Bestell-Nr. Order no.	ml	Box	*€/Stück *€/piece
814852SET	50	1	15,00

Set wird in Blisterverpackung geliefert.
Set besteht aus 1x Polierschwamm, 1x Mikrofaser Tuch und 50 ml Polierpaste.
Set comes in blister packaging.
Set consists 1x polishing sponge, 1x microfiber cloth and 50 ml polishing paste.

Universal Acrylpolierpaste Unipol
Universal acrylic polish paste Unipol

814853

Bestell-Nr. Order no.	ml	Box	*€/Stück *€/piece
814853	50	1	9,00



Universal Acrylpolierpaste Unipol - Set
Universal acrylic polish paste Unipol - Set

814854

Bestell-Nr. Order no.	ml	Box	*€/Stück *€/piece
814854SET	50	1	15,00

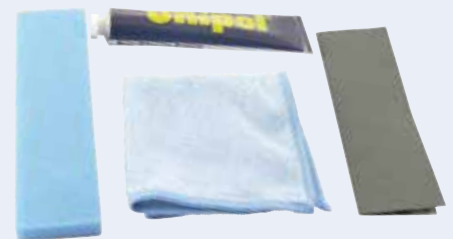

Set wird in Blisterverpackung geliefert.
Set besteht aus 1x Polierschwamm, 1x Mikrofaser Tuch, 2x Schleifpapier und 50 ml Polierpaste.
Set comes in blister packaging.
Set consists 1x polishing sponge, 1x microfiber cloth, 2x sand paper and 50 ml polishing paste.

Tikal Tef Gel
Tikal Tef Gel

814855

Bestell-Nr. Order no.	Gramm	Box	*€/Stück *€/piece
81485510	10	5	10,00
81485560	60	2	43,00

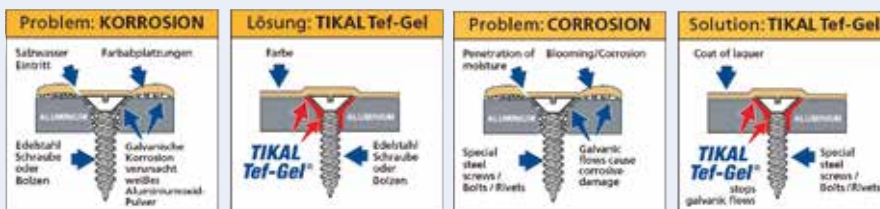

Keilsicherungsscheiben, schmal / 1.4547 (SM0254)
Wedge lock washers, standard

814856

Bestell-Nr. Order no.	D1	D2	S	Box	*€/Stück *€/piece
81485615065	6,5	10,8	2	20	1,62
81485615087	8,7	13,5	2	20	1,86
81485615107	10,7	16,6	2	20	2,12
81485615130	13,0	19,5	2	10	3,98
81485615170	17,0	25,4	3	10	7,16
81485615214	21,4	30,7	3	10	10,16
81485615253	25,3	39,0	3	10	23,62



Der Werkstoff 1.4547 ist besonders seewasserbeständig. 3000 Std. Salzwassersprühtest wurde ohne Korrosion überstanden.

Material 1.4547 is especially seawater resistant. Passed 3000 h salt water spray test without corrosion.

814857

Keilsicherungsscheiben, breit / 1.4547 (SMO254)

Wedge lock washers, wide



Bestell-Nr. Order no.	D1	D2	S	Box	*€/Stück *€/piece
81485715065	6,5	13,5	2	20	2,30
81485715087	8,7	16,6	2	20	2,84
81485715107	10,7	21,0	2	20	4,64
81485715130	13,0	25,4	2	10	10,68
81485715170	17,0	30,7	3	10	11,82
81485715214	21,4	39,0	3	10	26,15
81485715253	25,3	48,5	3	10	75,64

Der Werkstoff 1.4547 ist besonders seewasserbeständig. 3000 Std. Salzwassersprühtest wurde ohne Korrosion überstanden.

Material 1.4547 is especially seawater resistant. Passed 3000 h salt water spray test without corrosion.

814858

Klampe mit Gegenplatte / A4-AISI 316

Cleat with counterplate

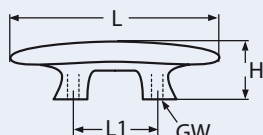

Bestell-Nr. Order no.	L	L1	H	GW	Box	*€/Stück *€/piece
8148584203	203	76	48	M10	1	92,00
8148584254	254	98,5	60	M12	1	150,00
8148584305	305	119	72	M16	1	206,00

Gegenplatte gefertigt aus Aluminium.
Counterplate made of aluminium.

814859

Klampe mit Gewinde und Gegenplatte / A4-AISI 316

Cleat with counterplate and thread

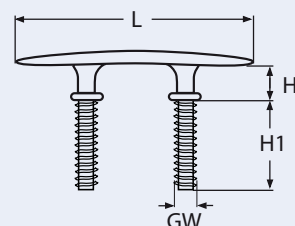

Bestell-Nr. Order no.	L	H	H1	GW	Box	*€/Stück *€/piece
8148594152	152	19	38	M8	1	36,00
8148594177	177	22	43	M8	1	53,00
8148594204	204	25	52	M12	1	56,00

Gegenplatte gefertigt aus Aluminium.
Counterplate made of aluminium.

Angelrutenhalter, verstellbar / A4-AISI 316
Fishing rod holder, adjustable

814860

Bestell-Nr. Order no.	L	D	A	B	Box	*€/Stück *€/piece
8148604230	230	45	89	60	1	73,00

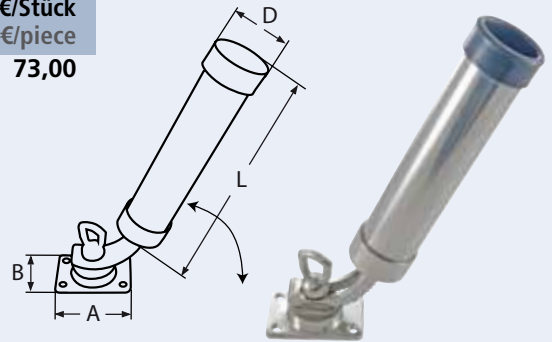

Angelrutenhalter / A4-AISI 316
Fishing rod holder

814861

Bestell-Nr. Order no.	L	D	Für Rohr-Ø For tube-Ø	Box	*€/Stück *€/piece
8148614285	285	45	30	1	76,00

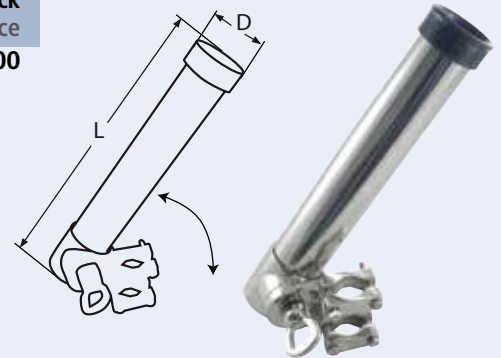

Ruckdämpfer mit Gummi-Schalldämpfer / A4-AISI 316
Mooring spring with rubber silencer

814862

Bestell-Nr. Order no.	Draht-Ø Wire-Ø	L	Box	*€/Stück *€/piece
814862405 300	5	300	1	25,00
814862406 300	6	300	1	34,00
814862409 470	9	470	1	108,00
814862411 470	11	470	1	132,00

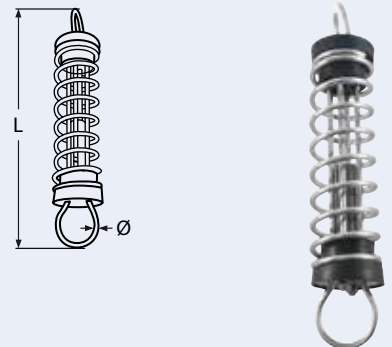

Auge mit Gewinde, rechts / A4-AISI 316
Threaded eye, right thread

814863

Bestell-Nr. Order no.	GW	A	A1	D	H	Box	*€/Stück *€/piece
814863405	M5	60	42	5,5	3	10	1,90
814863406	M6	66	48	6,5	4	10	2,00
814863408	M8	78	56	8,5	5	5	2,50
814863410	M10	91	63	10,5	6	5	3,30
814863412	M12	112	80	13,0	8	5	5,50

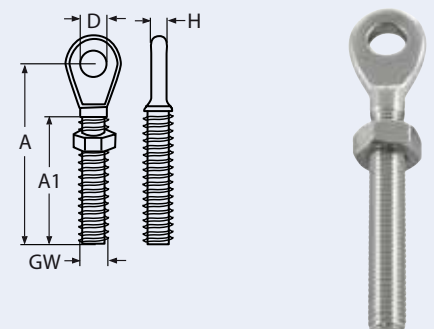

814864

Auge mit Gewinde, links / A4-AISI 316

Threaded eye, left thread

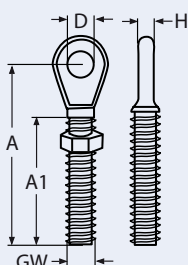

Bestell-Nr. Order no.	GW	A	A1	D	H	Box	*€/Stück *€/piece
814864405	M5	60	42	5,5	3	10	1,90
814864406	M6	66	48	6,5	4	10	2,00
814864408	M8	78	56	8,5	5	5	2,50
814864410	M10	91	63	10,5	6	5	3,30
814864412	M12	112	80	13,0	8	5	5,50

814865

Hakenterminal / A4-AISI 316

Hook terminal

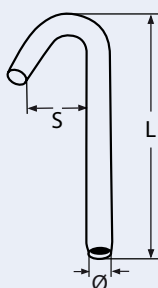

Bestell-Nr. Order no.	DS-Ø WS-Ø	L	S	Box	*€/Stück *€/piece
814865403	3	73	12	10	1,40
814865404	4	90	18	10	1,50

814866

ESS Gewindeterminale mit langem Gewinde, rechts / A4-AISI 316

ESS swage stud with long right thread

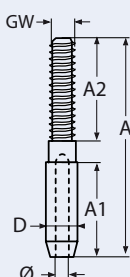

Bestell-Nr. Order no.	DS-Ø WS-Ø	GW	D	A	A1	A2	Box	*€/Stück *€/piece
814866405/3	3	M5	6,3	73	18	50	10	3,20
814866406/4	4	M6	7,5	89	25	60	10	3,50
814866408/5	5	M8	9,0	98	31	60	5	4,10
814866410/6	6	M10	12,5	124	37	80	5	5,60

814867

ESS Gewindeterminale mit langem Gewinde, links / A4-AISI 316

ESS swage stud with long left thread

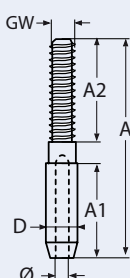

Bestell-Nr. Order no.	DS-Ø WS-Ø	GW	D	A	A1	A2	Box	*€/Stück *€/piece
814867405/3	3	M5	6,3	73	18	50	10	3,20
814867406/4	4	M6	7,5	89	25	60	10	3,50
814867408/5	5	M8	9,0	98	31	60	5	4,10
814867410/6	6	M10	12,5	124	37	80	5	5,60

ESS Schraubterminal mit Außengewinde / A4-AISI 316
ESS swage stud with outside thread

814868

Bestell-Nr. Order no.	DS-Ø WS-Ø	GW	D	A	A1	A2	Box	*€/Stück *€/piece
814868405/3	3	M5	11	87	53	34	5	5,90
814868406/4	4	M6	13	95	58	37	5	6,60
814868406/5	5	M6	14	102	65	37	2	7,30
814868408/6	6	M8	16	118	73	45	2	9,10

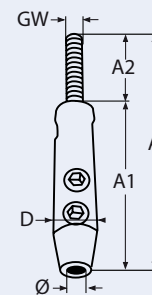

Schraubhaken / A2-AISI 304
Square Hooks

814869

Bestell-Nr. Order no.	Ø	S	L	L1	H	Box	*€/Stück *€/piece
8148692330	3,30	4,1	40	17	16	100	0,40
8148392345	3,45	4,3	50	20	18	100	0,50
8148692400	4,00	5,1	60	25	20	100	0,60
8148692440	4,40	5,5	80	32	22	100	0,80
8148692525	5,25	6,5	100	30	24	100	1,50

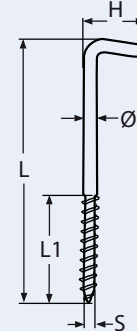

Spiralhaken mit Holzgewinde / A2-AISI 304
Curl hook with wood thread

814870

Bestell-Nr. Order no.	Ø	S	L	L1	D	Box	*€/Stück *€/piece
8148702088	8,8	10,8	120	45	24	100	0,90

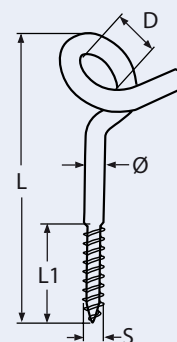

Spiralhaken mit metrischem Gewinde / A2-AISI 304
Curl hook with metric thread

814871

Bestell-Nr. Order no.	Ø	GW	L	L1	D	Box	*€/Stück *€/piece
8148712088	8,8	M10	120	45	24	100	0,60

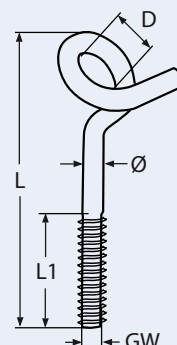

814872

Buchse für Bimini / Plastik
Connector for Bimini

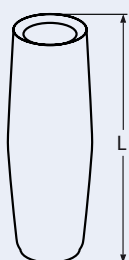

Bestell-Nr. Order no.	L	Für For	Box	*€/Stück *€/piece
8148723102	102	814309, 814310, 814311	10	3,10

Hauptkatalog Seite 309/310.
Catalogue page 309/310.

814873

Endkappe für Bimini / Plastik
End cap for Bimini

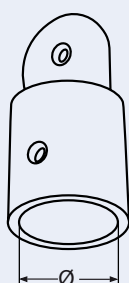

Bestell-Nr. Order no.	Ø	Für For	Box	*€/Stück *€/piece
814873321	21	814309, 814310, 814311	10	1,40

Hauptkatalog Seite 309/310.
Catalogue page 309/310.

814874

Sockel für Bimini / Plastik
Socket for Bimini

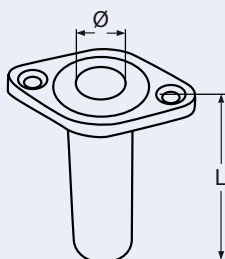

Bestell-Nr. Order no.	L	Ø	Für For	Box	*€/Stück *€/piece
814874355	55	12	814309, 814310, 814311	10	1,10

Hauptkatalog Seite 309/310.
Catalogue page 309/310.

814875

Gabel für Bimini / Plastik
Fork for Bimini

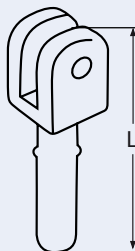

Bestell-Nr. Order no.	L	Für For	Box	*€/Stück *€/piece
814875373	73	814309, 814310, 814311	10	1,10

Hauptkatalog Seite 309/310.
Catalogue page 309/310.

Gelenk für Bimini / Plastik
Joint for Bimini

814876

Bestell-Nr. Order no.	L	Für For	Box	*€/Stück *€/piece
814876395	95	814309, 814310, 814311	10	3,00

Hauptkatalog Seite 309/310.
Catalogue page 309/310.

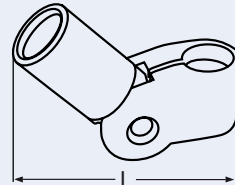

Abisolier- und Crimpwerkzeug
Stripping and crimping tool

814878

Bestell-Nr. Order no.	Box	*€/Stück *€/piece
8148783	1	60,00

Zum Abisolieren von 0,5 mm² bis 6,0 mm².
Zwei Pressbereiche für Verdrimpfungen (0,5 - 2,5 mm² und 4,0 - 6,0 mm²) nach DIN 46228-2.
Integrierter, gut zugänglicher Seitenschneider bis 6 mm².

For stripping of conductors from 0,5 to 6,0 mm².
Two crimping ranges are offered: 0,5 to 2,5 mm² (20-13 AWG) and 4,0 to 6,0 mm² (12-10 AWG).
Easily accessible built-in side cutter for max. 6,0 mm² (10 AWG).



Aderendhülsen Set
Bootlace ferrules set

814879

Bestell-Nr. Order no.	Box	*€/Stück *€/piece
8148793	1	30,00

Inhalt:	Content:
0,50 mm ² - 50 Stck.	0,50 mm ² - 50 pcs.
0,75 mm ² - 100 Stck.	0,75 mm ² - 100 pcs.
1,00 mm ² - 100 Stck.	1,00 mm ² - 100 pcs.
1,50 mm ² - 100 Stck.	1,50 mm ² - 100 pcs.
2,50 mm ² - 50 Stck.	2,50 mm ² - 50 pcs.



814880

ResQ-tape® Reparaturband

ResQ-tape® repair tape

Bestell-Nr. Order no.	Farbe Colour	Breite Width	Länge Length	Box	*€/Stück *€/piece
8148803S	schwarz / black	25	3650	2	13,40
8148803R	rot / red	25	3650	2	13,40
8148803T	transparent	25	3650	2	13,40
8148803W	weiss / white	25	3650	2	13,40
8148803B	blau / blue	25	3650	2	13,40



ResQ-tape® ist ein hochwertiges, selbstverschweißendes Silikon-Band für Notfälle und Reparaturen. Da ResQ-tape® nur an sich selbst haftet, kann es auch direkt auf nassen und schmutzigen Untergründen verarbeitet werden. Im Gegensatz zu herkömmlichen Klebebändern ist die Beschaffenheit des Untergrundes egal. Indem man das Band dehnt und überlappend um den zu reparierenden Gegenstand wickelt, entsteht innerhalb weniger Sekunden eine dauerhafte Verbindung.

ResQ-tape® kann eingesetzt werden um zwei Gegenstände zu verbinden oder um undichte Stellen zu reparieren. Es bildet blitzschnell eine dauerhafte luft- und wasserdichte Versiegelung. So können Sie z.B. Leckagen in Rohrleitungen oder Schläuchen reparieren und das Ganze funktioniert sogar unter Wasser! Auch kann das Band für elektrische Isolierungen eingesetzt werden, oder um die Griffe von Werkzeugen und Sportgeräte griffiger und rutschfest zu machen. Das ResQ-tape® lässt sich leicht und vollkommen rückstandsfrei auch von den empfindlichsten Untergründen entfernen, z.B. Chrom, Lacke, Stoffe, Kohlefaser, etc....

ResQ-tape®, made of pure silicone, is the most versatile self-fusing repair tape for emergencies and all-purpose repairs. ResQ-tape® is the strongest, fastest-fusing repair tape and can be used under very critical conditions. Just by stretching and wrapping it around an object onto itself, it will quickly and easily create a permanent airtight, waterproof seal in just seconds! It can even (without cleaning first) be used on dirty and wet surfaces. It will remain flexible and not become brittle after being exposed to sunlight.

ResQ-tape® let you repair leaks on plumbing and hoses in a flash, make underwater repairs, use it on electrical wiring or as shrink-wrap, wrap tool handles, connect two separate objects and much...much more! SPITA ResQ-tape® is easy to remove and will never leave a residue!!

Anwendungsbeispiele

Application examples

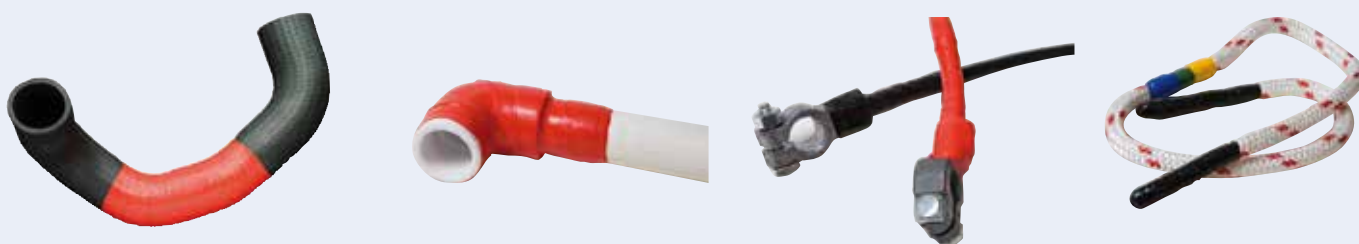

Hinweis: Maßänderungen bei allen Artikeln vorbehalten! Bruchlasten sind ca. Angaben.
Note: Measurement for all items under reserve. Breaking loads are approximate.



Marinotech Edelstahlhandel GmbH & Co. KG

D-28779 Bremen · Marschgehren 16
Fon: +49-421-69056-0 · Fax: +49-421-69056-50
www.marinotech.de · info@marinotech.de